

Alutecnic



DESCRIZIONE / DESCRIPTION

COLORI / COLOURS

Struttura / Frame Profili telo / Fabric profiles

-  RAL 9016 Bianco sablé
RAL 9016 White sand
-  RAL 1013 Avorio sablé
RAL 1013 Ivory sand
-  RAL 9006 Grigio sablé
RAL 9006 Grey sand
-  RAL 9010 Bianco semilucido
RAL 9010 White semi-gloss
-  RAL 1013 Avorio semilucido
RAL 1013 Ivory semi-gloss
-  RAL 9006 Alluminio brillante opaco
RAL 9006 Bright aluminium matt
-  Grigio ferro
Iron grey
-  Corten

Con supplemento / With extra charge

-  Tiger Coating
Colours Class 2
-  RAL altro
RAL other

Parti plastiche / Plastic parts **B2B**

-  Bianco
White
-  Avorio
Ivory
-  Grigio ferro •
Iron grey •
-  Corten •

Le parti in plastica non sono verniciabili e sono disponibili esclusivamente nelle colorazioni indicate.

Plastic parts can't be lacquered and are available only in the colours above mentioned.

• Colorazione non disponibile per le plastiche dei profili telo / Colours not available for the fabric profiles plastic elements

Tettuccio /
Hood

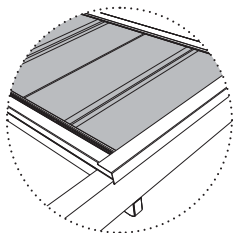

Profilo gronda /
Gutter profile

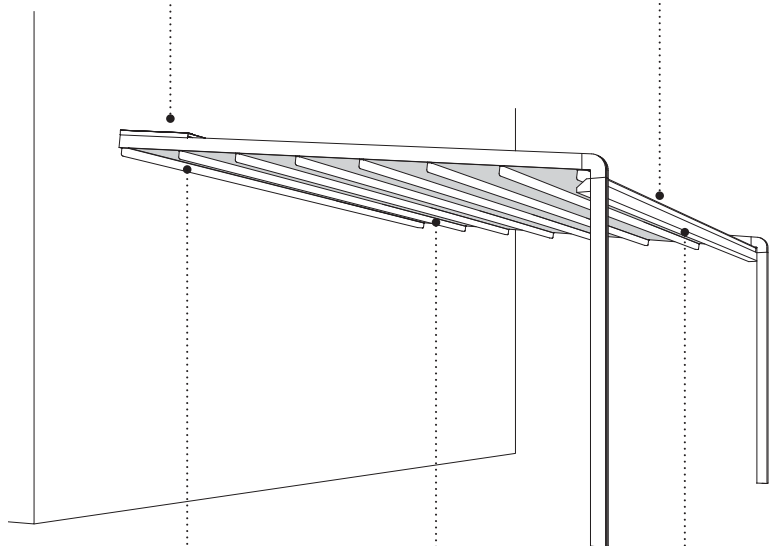
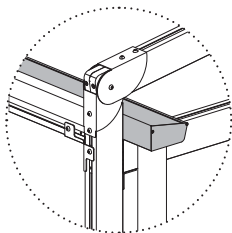

Sottotelo /
Undercover

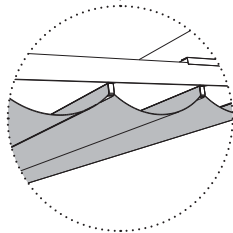

LED Line sui
rompitratte /
Dimmable LED Line
on the ribs

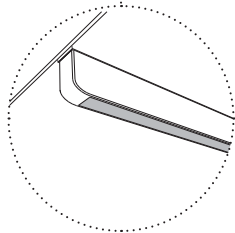

Serie Windy /
Windy series

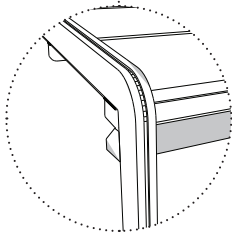

ALU INOX CE

La riproduzione dei colori è indicativa /
The reproduction of colours is approximate